

Panasonic

SCROLL COMPRESSORS

Code : 809 185 88

Model : C-SCN603H8T

PANASONIC APPLIANCES COMPRESSOR (DALIAN) CO., LTD.

Rev.2020-3

Scroll Compressor

Model C-SCN603H8T

Refrigerant R407C

Electrical 380-415 Volts 3 Phase 50Hz

440-460 Volts 3 Phase 60Hz

Nominal Performance at ARI

| | | |
|------------------|------------------|------------------|
| Power Source | <u>50Hz-380V</u> | <u>60Hz-440V</u> |
| Capacity (W) | <u>24500</u> | <u>29100</u> |
| Power (W) | <u>7750</u> | <u>9450</u> |
| Current (A) | <u>13.2</u> | <u>13.9</u> |
| COP (W/W) | <u>3.16</u> | <u>3.08</u> |
| Mass Flow (kg/h) | <u>589</u> | <u>700</u> |

Rating Conditions (MID Point)

| | |
|-----------------------------|-------------|
| Condensing Temperature(°C) | <u>54.4</u> |
| Evaporating Temperature(°C) | <u>7.2</u> |
| Return Gas temperature(°C) | <u>18.3</u> |
| Liquid Temperature(°C) | <u>43.8</u> |
| Ambient Temperature(°C) | <u>35</u> |

Motor

| | 50Hz | 60Hz |
|--------------------------|----------------|----------------|
| Voltage Range(V) | <u>342-456</u> | <u>396-506</u> |
| RLA (A) | <u>15.9</u> | |
| MCC (A) | <u>22.2</u> | |
| LRA (A) | <u>80</u> | <u>84</u> |
| RPM (min ⁻¹) | <u>2900</u> | <u>3450</u> |

Compressor

| | |
|-------------------------------------|-------------|
| Maximum Discharge Temp(°C) | <u>135</u> |
| Displacement (cm ³ /rev) | <u>137</u> |
| Weight (with oil kg) | <u>66.5</u> |

Oil

| | |
|---------------------|--------------|
| Oil Type | <u>FV68S</u> |
| Initial Charge (ml) | <u>2800</u> |
| Re-charge (ml) | <u>2600</u> |

Electrical Components

| | |
|----------------------------------|-----------------|
| Motor Protector Type | <u>Internal</u> |
| Run Capacitor Rating (MFD/Volts) | <u>n/a</u> |

Nominal performance values +/-5% with 1 hr run-in.

Ratings with air over compressor.

Specifications subject to change without notice.

PERFORMANCE DATA

| | |
|--------------------------|---------------------------------|
| Compressor Model(Code) | C-SCN603H8T (809 185 88) |
| Power Source | 3PH 50Hz 380-415V |
| Suction Gas Superheat(K) | 9 |
| Sub Cooling(K) | 8.3 |
| Compressor Cooling | Natural Cooling |
| Refrigerant | R407C |

CAPACITY(W)

| Condensing Temperature(°C) | Evaporating Temperature(°C) | | | | | | | |
|----------------------------|-----------------------------|--------|--------|--------|--------|--------|--------|--------|
| | -15 | -10 | -6.7 | 0 | 4.4 | 7.2 | 10 | 12 |
| 35.0 | 13,210 | 16,230 | 18,590 | 24,490 | 29,350 | 32,930 | 36,960 | 40,130 |
| 40.5 | 12,180 | 14,950 | 17,130 | 22,550 | 27,020 | 30,310 | 34,010 | 36,920 |
| 45.0 | 11,380 | 13,980 | 16,000 | 21,070 | 25,230 | 28,310 | 31,750 | 34,470 |
| 50.0 | 10,560 | 12,960 | 14,830 | 19,520 | 23,370 | 26,220 | 29,400 | 31,910 |
| 54.4 | | 12,120 | 13,870 | 18,250 | 21,850 | 24,500 | 27,470 | 29,820 |
| 60.0 | | | 12,750 | 16,760 | 20,060 | 22,480 | 25,210 | 27,350 |
| 65.0 | | | | 15,540 | 18,590 | 20,840 | 23,360 | 25,350 |

POWER(W)

| Condensing Temperature(°C) | Evaporating Temperature(°C) | | | | | | | |
|----------------------------|-----------------------------|-------|-------|-------|-------|-------|-------|-------|
| | -15 | -10 | -6.7 | 0 | 4.4 | 7.2 | 10 | 12 |
| 35.0 | 5,020 | 5,090 | 5,120 | 5,160 | 5,160 | 5,160 | 5,140 | 5,120 |
| 40.5 | 5,600 | 5,680 | 5,720 | 5,770 | 5,770 | 5,770 | 5,750 | 5,740 |
| 45.0 | 6,140 | 6,230 | 6,270 | 6,330 | 6,340 | 6,340 | 6,330 | 6,320 |
| 50.0 | 6,810 | 6,910 | 6,960 | 7,030 | 7,050 | 7,050 | 7,050 | 7,040 |
| 54.4 | | 7,570 | 7,630 | 7,710 | 7,740 | 7,750 | 7,750 | 7,740 |
| 60.0 | | | 8,570 | 8,670 | 8,710 | 8,730 | 8,740 | 8,740 |
| 65.0 | | | | 9,610 | 9,660 | 9,690 | 9,700 | 9,710 |

CURRENT(A)

@380V

| Condensing Temperature(°C) | Evaporating Temperature(°C) | | | | | | | |
|----------------------------|-----------------------------|------|------|------|------|------|------|------|
| | -15 | -10 | -6.7 | 0 | 4.4 | 7.2 | 10 | 12 |
| 35.0 | 9.3 | 9.3 | 9.3 | 9.3 | 9.3 | 9.3 | 9.3 | 9.3 |
| 40.5 | 10.1 | 10.2 | 10.2 | 10.2 | 10.2 | 10.2 | 10.2 | 10.2 |
| 45.0 | 10.9 | 11.0 | 11.0 | 11.1 | 11.1 | 11.1 | 11.1 | 11.1 |
| 50.0 | 11.8 | 11.9 | 12.0 | 12.1 | 12.2 | 12.2 | 12.2 | 12.2 |
| 54.4 | | 12.9 | 13.0 | 13.1 | 13.2 | 13.2 | 13.2 | 13.2 |
| 60.0 | | | 14.3 | 14.5 | 14.6 | 14.6 | 14.6 | 14.6 |
| 65.0 | | | | 15.9 | 16.0 | 16.0 | 16.0 | 16.0 |

NOTE:

- * The performance values are based on MID point method.
- * The performance values subject to change without notice.

Compressor Model(Code)
Power Source

C-SCN603H8T (809 185 88)
3PH 50Hz 380-415V

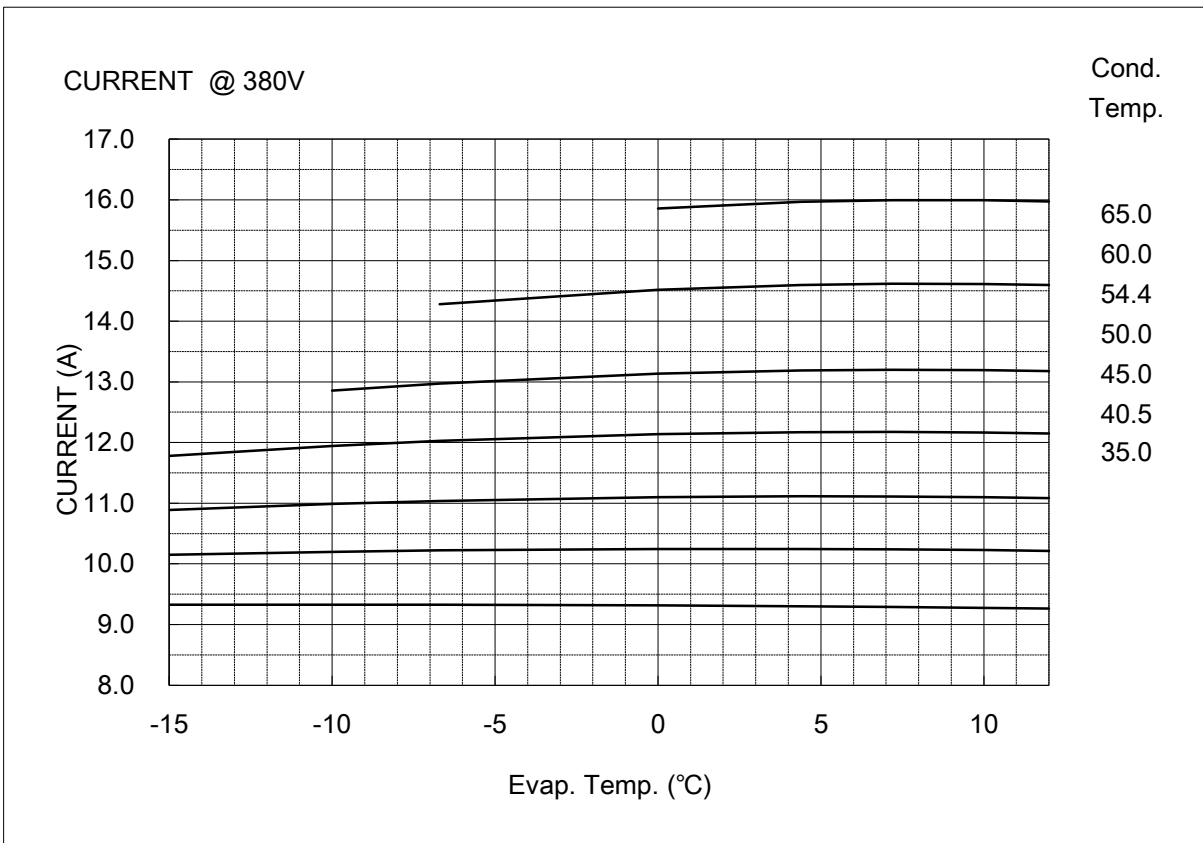
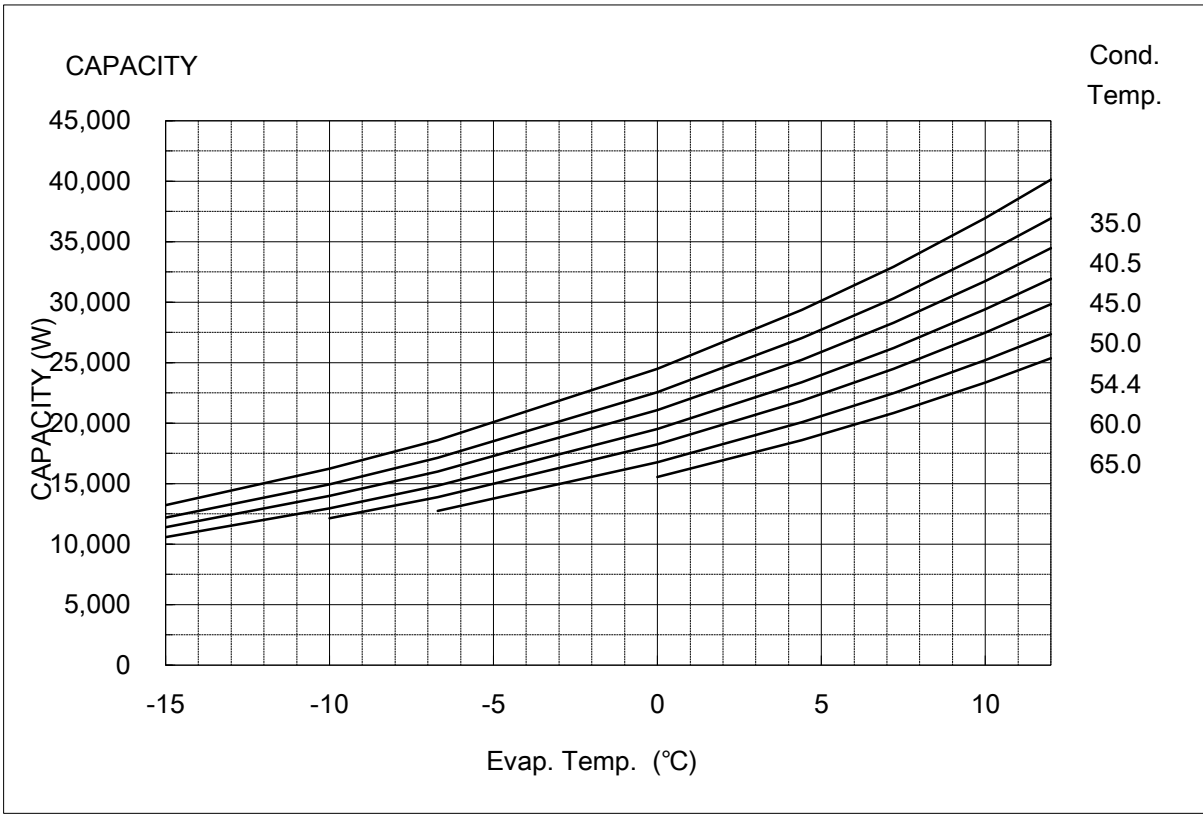

COEFFICIENTS OF PERFORMANCE CURVES

Compressor Model **C-SCN603H8T (809 185 88)**
 Power Source **3PH 50Hz 380-415V**
 Suction Gas Superheat (K) **9**
 Sub Cooling (K) **8.3**
 Compressor Cooling **Natural Cooling**
 Refrigerant **R407C**

$$X=C1+C2*(S)+C3*D+C4*(S^2)+C5*(S*D)+C6*(D^2)+C7*(S^3)+C8*(D*S^2)+C9*(S*D^2) +C10*(D^3)$$

X—CAPACITY(W) OR POWER(W) OR CURRENT(A) OR FLOW(kg/h)

S—EVAPORATING TEMP, °C

D—CONDENSING TEMP, °C

| <u>380V-50Hz</u> | CAPACITY (W) | POWER (W) | CURRENT (A) |
|-------------------------|---------------|---------------|---------------|
| C1 | 4.004642E+04 | 3.569299E+03 | 6.084165E+00 |
| C2 | 1.707960E+03 | 5.038327E+00 | -4.586390E-03 |
| C3 | -5.239410E+02 | -9.795056E+00 | 2.441731E-02 |
| C4 | 3.105100E+01 | -4.003621E-01 | 1.879734E-03 |
| C5 | -2.365733E+01 | -3.377715E-01 | -5.175950E-04 |
| C6 | 2.263373E+00 | 1.580085E+00 | 1.935642E-03 |
| C7 | 2.389230E-01 | 1.053029E-04 | -2.682842E-06 |
| C8 | -2.845702E-01 | -2.093382E-03 | -5.562160E-05 |
| C9 | 1.090986E-01 | 7.518378E-03 | 1.672233E-05 |
| C10 | -3.152917E-08 | 5.700804E-09 | 6.634405E-12 |

Note:The polynomial coefficients subject to change without notice.

PERFORMANCE DATA

| | |
|--------------------------|---------------------------------|
| Compressor Model(Code) | C-SCN603H8T (809 185 88) |
| Power Source | 3PH 60Hz 440-460V |
| Suction Gas Superheat(K) | 9 |
| Sub Cooling(K) | 8.3 |
| Compressor Cooling | Natural Cooling |
| Refrigerant | R407C |

CAPACITY(W)

| Condensing Temperature(°C) | Evaporating Temperature(°C) | | | | | | | |
|----------------------------|-----------------------------|--------|--------|--------|--------|--------|--------|--------|
| | -15 | -10 | -6.7 | 0 | 4.4 | 7.2 | 10 | 12 |
| 35.0 | 16,340 | 19,980 | 22,820 | 29,900 | 35,690 | 39,950 | 44,720 | 48,480 |
| 40.5 | 14,900 | 18,240 | 20,840 | 27,330 | 32,650 | 36,560 | 40,950 | 44,400 |
| 45.0 | 13,810 | 16,910 | 19,330 | 25,370 | 30,330 | 33,970 | 38,060 | 41,280 |
| 50.0 | 12,680 | 15,540 | 17,770 | 23,340 | 27,920 | 31,290 | 35,070 | 38,040 |
| 54.4 | | 14,420 | 16,500 | 21,690 | 25,960 | 29,100 | 32,620 | 35,400 |
| 60.0 | | | 15,020 | 19,760 | 23,660 | 26,540 | 29,770 | 32,310 |
| 65.0 | | | | 18,200 | 21,810 | 24,480 | 27,460 | 29,820 |

POWER(W)

| Condensing Temperature(°C) | Evaporating Temperature(°C) | | | | | | | |
|----------------------------|-----------------------------|-------|--------|--------|--------|--------|--------|--------|
| | -15 | -10 | -6.7 | 0 | 4.4 | 7.2 | 10 | 12 |
| 35.0 | 5,940 | 6,090 | 6,170 | 6,270 | 6,290 | 6,290 | 6,270 | 6,240 |
| 40.5 | 6,660 | 6,820 | 6,900 | 7,000 | 7,030 | 7,030 | 7,020 | 7,000 |
| 45.0 | 7,340 | 7,500 | 7,580 | 7,690 | 7,720 | 7,730 | 7,720 | 7,710 |
| 50.0 | 8,190 | 8,340 | 8,420 | 8,540 | 8,590 | 8,600 | 8,610 | 8,600 |
| 54.4 | | 9,160 | 9,240 | 9,370 | 9,430 | 9,450 | 9,470 | 9,470 |
| 60.0 | | | 10,400 | 10,530 | 10,600 | 10,640 | 10,680 | 10,700 |
| 65.0 | | | | 11,670 | 11,760 | 11,810 | 11,860 | 11,900 |

CURRENT(A)

@440V

| Condensing Temperature(°C) | Evaporating Temperature(°C) | | | | | | | |
|----------------------------|-----------------------------|------|------|------|------|------|------|------|
| | -15 | -10 | -6.7 | 0 | 4.4 | 7.2 | 10 | 12 |
| 35.0 | 8.3 | 8.7 | 9.0 | 9.3 | 9.3 | 9.3 | 9.3 | 9.2 |
| 40.5 | 9.5 | 9.9 | 10.1 | 10.3 | 10.4 | 10.4 | 10.4 | 10.3 |
| 45.0 | 10.6 | 11.0 | 11.1 | 11.4 | 11.4 | 11.4 | 11.4 | 11.4 |
| 50.0 | 12.2 | 12.4 | 12.5 | 12.6 | 12.7 | 12.7 | 12.7 | 12.7 |
| 54.4 | | 13.7 | 13.8 | 13.8 | 13.9 | 13.9 | 13.9 | 14.0 |
| 60.0 | | | 15.6 | 15.5 | 15.6 | 15.6 | 15.7 | 15.8 |
| 65.0 | | | | 17.2 | 17.2 | 17.3 | 17.4 | 17.6 |

NOTE:

- * The performance values are based on MID point method.
- * The performance values subject to change without notice.

Compressor Model(Code)
Power Source

C-SCN603H8T (809 185 88)
3PH 60Hz 440-460V

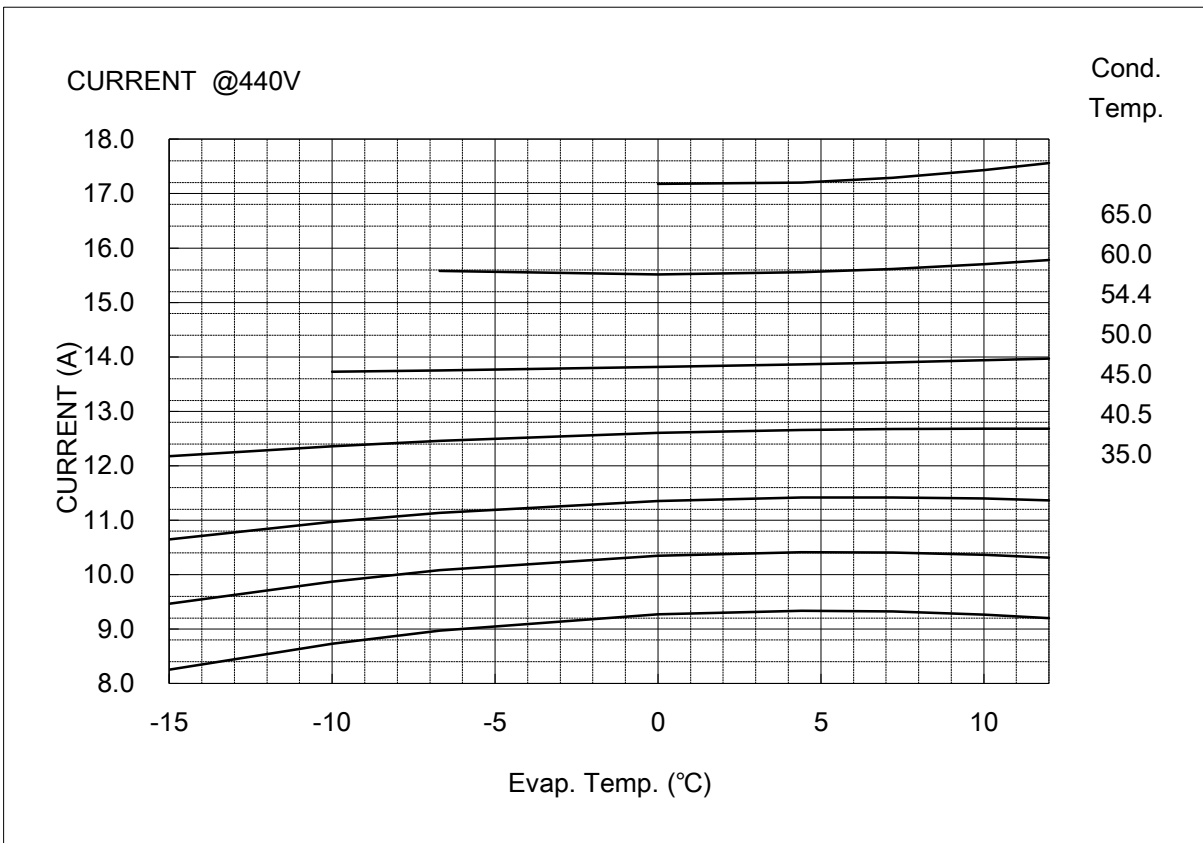
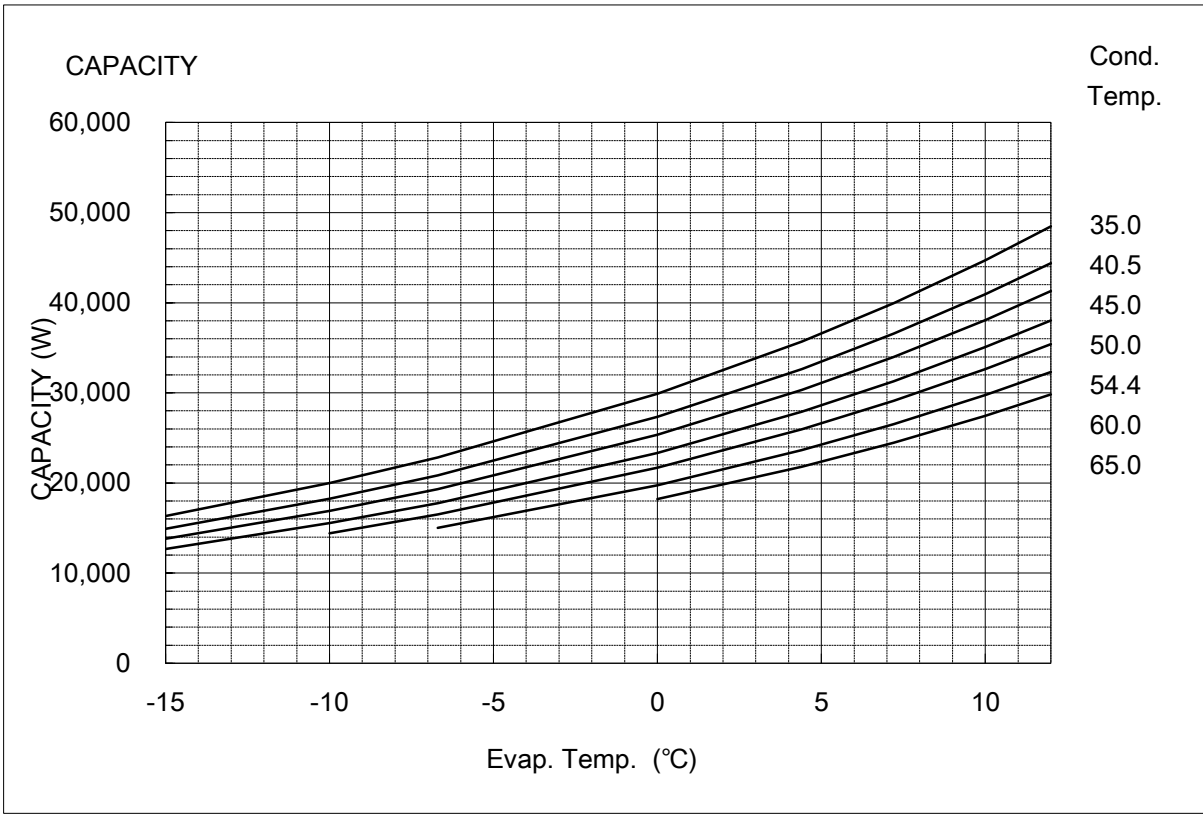

COEFFICIENTS OF PERFORMANCE CURVES

Compressor Model **C-SCN603H8T (809 185 88)**
 Power Source **3PH 60Hz 440-460V**
 Suction Gas Superheat (K) **9**
 Sub Cooling (K) **8.3**
 Compressor Cooling **Natural Cooling**
 Refrigerant **R407C**

$$X=C1+C2*(S)+C3*D+C4*(S^2)+C5*(S*D)+C6*(D^2)+C7*(S^3)+C8*(D*S^2)+C9*(S*D^2) +C10*(D^3)$$

X—CAPACITY(W) OR POWER(W) OR CURRENT(A) OR FLOW(kg/h)

S—EVAPORATING TEMP, °C

D—CONDENSING TEMP, °C

| <u>440V-60Hz</u> | CAPACITY (W) | POWER (W) | CURRENT (A) |
|-------------------------|---------------|---------------|---------------|
| C1 | 5.079741E+04 | 4.383964E+03 | 6.908819E+00 |
| C2 | 2.055610E+03 | 1.235758E+01 | 1.760747E-02 |
| C3 | -7.097991E+02 | -1.385735E+01 | -3.705640E-02 |
| C4 | 3.586250E+01 | -1.684597E+00 | -9.046854E-03 |
| C5 | -2.879854E+01 | -4.162538E-01 | 7.744920E-04 |
| C6 | 3.208373E+00 | 1.938782E+00 | 3.009590E-03 |
| C7 | 2.766718E-01 | 1.809265E-03 | 1.504425E-05 |
| C8 | -3.199017E-01 | 2.093213E-02 | 1.702135E-04 |
| C9 | 1.330703E-01 | 8.630991E-03 | -1.647913E-05 |
| C10 | -1.647169E-08 | -1.231354E-08 | -7.266176E-11 |

Note:The polynomial coefficients subject to change without notice.

DIMENSIONAL SKETCH

C-SC Series

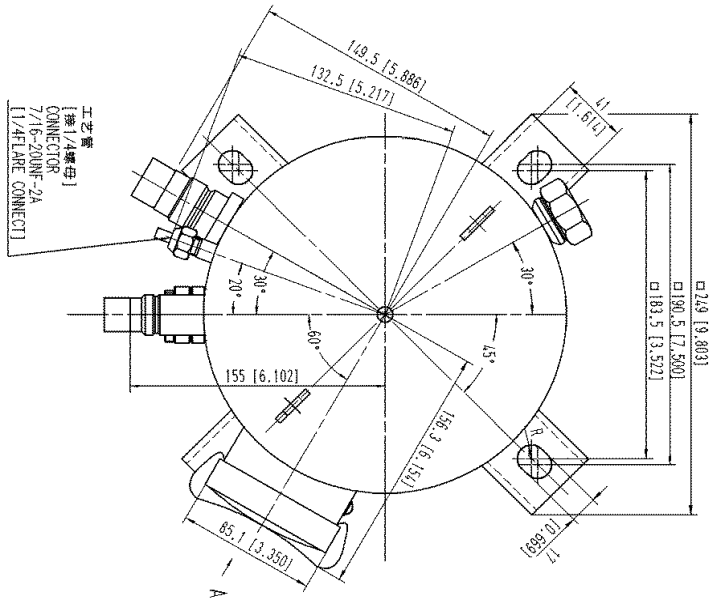
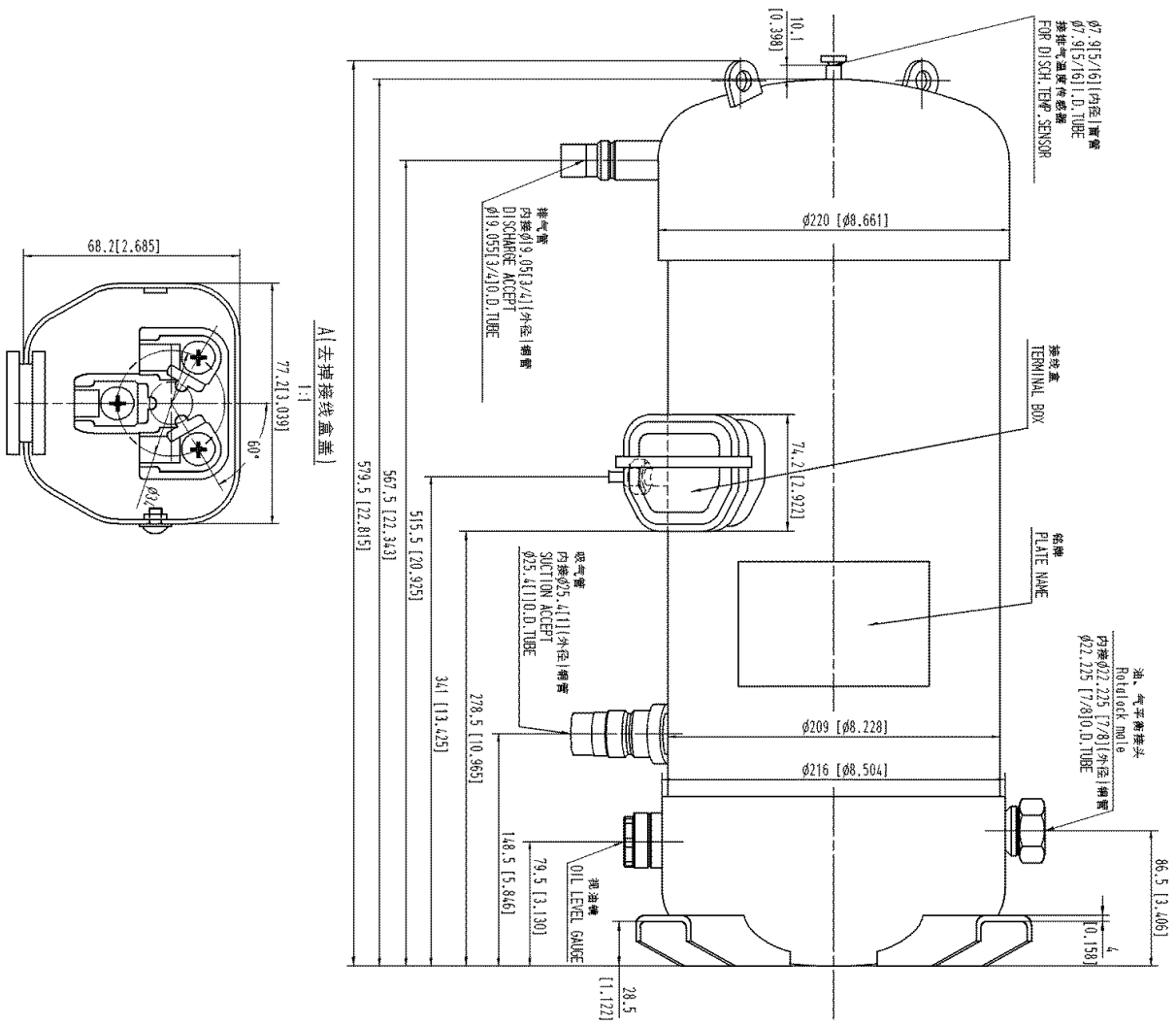

WIRING & MOUNTING SKETCH

WIRING DIAGRAM C-SC Series 3phase B8

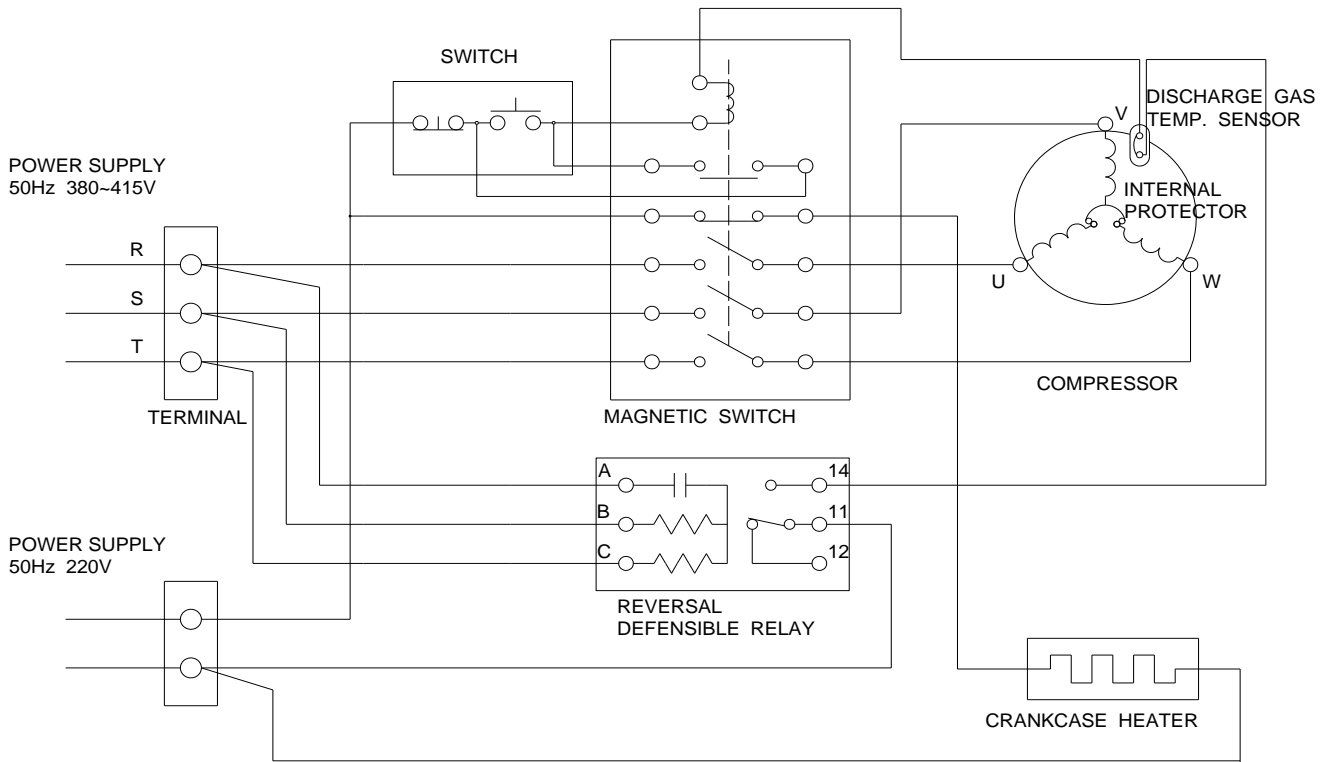

MOUNTING SKETCH

